



User's Manual

For use with ProSYS 16, ProSYS 40,
and ProSYS 128



Important Notice

This manual is delivered subject to the following conditions and restrictions:

- ◆ This manual contains proprietary information belonging to RISCO Group. Such information is supplied solely for the purpose of assisting explicitly and properly authorized users of the system.
- ◆ No part of its contents may be used for any other purpose, disclosed to any person or firm or reproduced by any means, electronic or mechanical, without the express prior written permission of RISCO Group.
- ◆ The text and graphics are for the purpose of illustration and reference only. The specifications on which they are based are subject to change without notice.
- ◆ Information in this document is subject to change without notice. Corporate and individual names and data used in examples herein are fictitious unless otherwise noted.







Copyright © 2009 RISCO Group. All rights reserved.

RTTE Declaration of Conformity

Hereby, RISCO Group, declares that this control panel (ProSYS128, ProSYS40, ProSYS16), with wired accessories (including cables) and wireless accessories, is in compliance with the essential requirements and other relevant provisions of Directive 1999/5/EC.

For the CE Declaration of Conformity please refer to our website:
www.riscogroup.com.

Table of Contents

SUMMARY OF USER COMMANDS.....	6
CHAPTER 1: INTRODUCTION.....	8
Operating the System	9
The ProSYS Family.....	10
Terms and Definitions	11
CHAPTER 2: YOUR KEYPAD	13
Keypad Types.....	13
LED Indicators	14
Power/  LED.....	14
Arm/  LED	15
Ready/  LED	15
Bypass/  LED	16
Fire/  LED	16
Tamper/  LED.....	16
Zone LEDs.....	17
Keys.....	17
Numerical Keys	17
Function Keys (A, B, C and D)	17
Control Keys	18
Emergency Keys	18
Quick Key Operation	19
LCD Status Display	19
LCD Blank Display	19
CHAPTER 3: ARMING AND DISARMING THE SYSTEM	20
Arming.....	20
Away Arming	20
Stay Arming	21

- Partition Arming 22
- Arming Multiple Partitions..... 23
- Group Arming 24
- Quick Arming 24
- Force Arming..... 25
- Wireless Button Arming 25
- Proximity Tag Arming 25
- Keyswitch Arming..... 25
- Access Control Arming..... 25
- Disarming 26**
 - Disarming the System..... 26
 - Silencing an Alarm 26
 - Partition Disarming..... 27
 - Duress Disarming..... 28
 - Disabling the Fire Alarm (Switch Auxiliary)..... 29
- CHAPTER 4: ZONE BYPASSING 30**
- CHAPTER 5: ACTIVATING HOME APPLIANCES (UOS) 32**
 - Activating Home Appliances from the User Functions Menu..... 33
 - Activating Home Appliances by Entering a Code..... 33
- CHAPTER 6: SETTING FOLLOW ME DESTINATIONS 34**
- CHAPTER 7: USER CODES 36**
 - Setting and Changing User Codes 36
 - Deleting User Codes 37
 - User Authority Levels 38
 - Entering User Labels 39
 - Character Table 40
 - Assigning Double Codes 41
- CHAPTER 8: VIEWING TROUBLE CONDITIONS 42**
- CHAPTER 9: SETTING AND CHANGING SYSTEM TIME AND DATE 43**
 - Setting and Changing System Time..... 43

Setting and Changing System Date 44

CHAPTER 10: DEFINING WEEKLY SCHEDULES 45

 Automatic Arming/Disarming 45

 Defining a UO Activation Schedule 48

 Defining a User Limitation Schedule 50

CHAPTER 11: PROGRAMMING FUNCTION KEYS 52

 Using the Arm Key to Program Function Keys 53

CHAPTER 12: PROXIMITY KEYPAD 55

 Adding a New Proximity Tag 55

 Deleting a Proximity Tag By the User Serial Number 56

 Deleting a Proximity Tag By the User Tag 57

 Using a Proximity Tag 58

CHAPTER 13: COMPLETE MENU OF USER FUNCTIONS 59

APPENDIX A: SYSTEM TROUBLES 66

APPENDIX B: SYSTEM SOUNDS 68

APPENDIX C: SCHEDULING TABLES 70

Summary of User Commands

Away Arm	Hold the tag close to the keypad's keys -OR- Code> /
Stay Arm	Code> /
Group Arm	Code>A/B/C/D
Partition Away Arm	Hold the tag close to the keypad's keys > Partition No. > / -OR- Code> / > Partition No. > /
Partition Stay Arm	Code> / > Partition No. > /
Partition Group Arm	Code>A/B/C/D > Partition No. > A/B/C/D
System Disarm	Hold the tag close to the keypad's keys -OR- Code> /
Partition Disarm	Hold the tag close to the keypad's keys > Partition No. > / -OR- Code> / > Partition No. > /
Duress Disarm	Duress Code > /
Silence an Alarm	Hold the tag close to the keypad's keys -OR- Code> /
Bypass Zones	> [1]>[1]>[Code]> / > [Zone No.]
Activate Utility Output	> [2]>[1]>[Code] > / [UO No.]
Define Follow-Me	> [2]>[7]>[Code] > /
Enable Installer Menu	> [7]>[1]>[Installer Code]> /
View Trouble	> [3]>[1]>[Code] > /
View Alarm Memory	> [3]>[2]>[Code]> /

View Zone Status

*->[3]>[4]>[Code]>  / 

View Event Log

*->[3]>[5]>[Manager Code]>  / 

Bell/Strobe/Keypad Test

*->[4]>[Code]>  / ->[1]

Zone Testing (Walk Test)

*->[4]>[Grand Master Code]>  / ->[0]>[1]

Local Chime On/Off

*->[4]>[Code]>  / ->[4]/[3]

Edit User Code

*->[5]>[Code]>  / ->[1]



Edit Time

*->[6]>[Grand Master Code]>  / ->[1]

Edit Date

*->[6]>[Grand Master Code]>  / ->[2]

Automatic Arming/Disarming

*->[6]>[Grand Master Code]>  / ->[5]>[Schedule No]>[1]

Chapter 1: Introduction

Congratulations on your purchase of RISCO Group's ProSYS Security System. The ProSYS has been specifically designed to meet a wide range of security needs for many residential and commercial applications.

The ProSYS includes the most advanced communication capabilities for dual or triple-path communication to Monitoring Stations (MSs) using telephone lines, GSM/GPRS network or TCP/IP network. It consists of a variety of sensors, detectors, and contacts placed throughout the premises. It is designed to recognize abnormal conditions and inform the system of the status of any protected door, window, hallway, room, or area.

The Main Panel, which contains the system's electronics and backup battery, functions in the background. For security purposes, it is recommended that it be installed out of sight.

You can place a household appliance or premises lighting under the control of the ProSYS, where it can be conveniently turned on and off automatically or by user command from any system keypad, as described on page 32.

In addition, the ProSYS supports the following optional RISCO Group devices:

- ◆ Advanced Communication Module that enables the system to operate over the IP network.
- ◆ GSM/GPRS module which enables the system to communicate over the GSM/GPRS network, and also send or receive SMS commands.
- ◆ Access Control, which enables integrating access control capabilities into your security system.
- ◆ Digital Voice Module which enables you to receive voice messages, operate the system from a remote phone, and listen- in or speak to the premises.

Operating the System

The ProSYS can easily be operated locally or remotely depending on the devices connected to the system.

You can issue commands to the system and in turn, the system will communicate information to you via its display, indicators, voice messages, SMS messages, Email messages and by the sounds it makes.

The ProSYS can be operated in the following ways:

- ◆ Locally through its keypad(s). There are two types of keypads: one with an LED, and the other with an LCD. Using its keys, you can issue commands to your system. In turn, the system can communicate information to you via its display, indicators and by the sounds it makes. See page 13 for a description of the different types of keypads.



- ◆ Locally or remotely using RISCO Group's Upload/ Download software. The Upload/Download software enables the installer to program the system, and enables the user to operate the system and to view system status.
- ◆ If your system is appropriately equipped, it can be armed using a keyswitch, proximity tag or a wireless button key. These features must be programmed by your installer.
- ◆ If your system is equipped with RISCO Group's GSM/GPRS module it can provide information about the system by SMS and enable operation of the system using SMS commands for arming the system, disarming the system and more. For details information refer to the manual provided with the GSM/GPRS module.
- ◆ If your system includes the Voice module, it can provide audible information about system status, and enable any remote, touch-tone (DTMF) telephone to act as a keypad for the system. Upon event occurrence, such as alarm activation, the Voice module informs you of a security situation by calling you and playing a prerecorded Event announcement, as described in the *Voice Module Programming and*

The first task to be performed before operating the system is *Setting and Changing User Codes*, as described on page 36.



NOTE:

A certified serviceman should do all repairs and maintenance including replacement of the device battery.

The ProSYS Family

This manual is intended for all three types of panels in the ProSYS family. The following table lists the number of features in each type of panel.

Feature	ProSYS 16	ProSYS 40	ProSYS 128
Total Zones	8 - 16	8 - 40	8 - 128
User Codes	30	60	99
Utility Outputs	6 - 22	6 - 38	6 - 70
Follow-Me Destinations	8	8	16
Maximum Keypads	8	12	16
Partitions	4	4	8
Weekly Schedules	8	16	32

Terms and Definitions

There are a few terms with which you should become familiar. Knowing them will help you to better understand and use your system.

Authority Level: Each individual using the system is assigned a user code, which, in turn, is linked to an Authority Level. Those with a "higher authority" have access to a greater number of system functions, while those with a "lower authority" are more restricted in what they may do. There are nine different Authority Levels available for users of the ProSYS, as described on page 38.

Chime: The chime is a series of three short keypad tones, which can be set up to annunciate, during the disarmed period, the violation of selected intrusion zone(s). For example, the chime tone can be used to annunciate the arrival of a customer each time the front door opens. The chime can be disabled or enabled at your discretion.

Event Log: A list of system events can be displayed on an LCD keypad or uploaded to the Monitoring Station via the Upload/Download software and printed for further analysis.

Exit/Entry Delay: Your security system must incorporate an entry/exit delay to allow proper entry and exit to and from the premises without causing inadvertent alarms.

Follow-Me Destinations: In addition to the standard event reporting to the Monitoring Station, the system can send event messages to a designated system user's telephone/email.

Group: A number of zones gathered as one unit to allow partial arming. Each zone can be assigned to any one (or a combination) of four groups (A, B, C or D). Each partition can be divided into a maximum of four groups.

Keyswitch: Your system may also be equipped with a keyswitch, which is useful for simple arming and disarming operations (usually at a remote location).

Monitoring Station: Your system is set up to report alarms to a Monitoring Station, which is a facility that continually monitors the activities of many security systems (usually via the telephone network) and dispatches the proper authorities.

Partition: One of the ProSYS advantages is its ability to divide any system into a number of partitions. You can think of each partition as a separate security system that can be armed and disarmed individually.

Proximity: A technology that enables a keypad to sense when a proximity key tag is near it. This provides an easy and user-friendly way to arm or disarm the security system.

Tamper: A device that prevents system hardware from being tampered with by triggering an alarm whenever a hardware component is opened.

Trouble Reporting: If required, your security system may also report to the Monitoring Station any troubles or malfunctions it senses, so that a service call can be made.

Upload/Download: Software used by the installer for programming the ProSYS and by the user for operating the system and viewing system status.

User Code: Up to a four-digit or six-digit code that is used to perform many of the ProSYS functions.

Utility Output (UO): A household appliance. In addition to your system's normal operation, it is possible to place a household appliance or premises lighting under the control of the ProSYS where it can be conveniently turned on and off automatically, or by user command from any system keypad.

Weekly Schedules: Through the use of the system's built-in clock, it is possible to schedule automatic operations such as arming and disarming, UO activation, and user limitation.

Zone: A single detector, or collection of detectors, usually relating to a certain area of the premises or type of protection. Zones that use devices designed to detect break-ins are called intrusion zones. Another kind of zone may contain one or more smoke detectors. Such zones are called fire zones. An environmental zone typically protects the premises from gas leaks and/or flooding.

Chapter 2: Your Keypad

As a user of your security system, you'll need to be primarily concerned with the keypad. This section discusses the keypad's visual indicators and the use of its keys.

Each keypad in the system is assigned to a particular partition, meaning that commands entered in a keypad are implemented only in the partition to which it is assigned. For example, pressing the Quick Arm key on a keypad assigned to partition 1 arms only partition 1.

Each keypad in your system reports its status via its LED (lighted) indicators at the left, as described on page 14. Through its keys, you can enter commands to arm and disarm the system, bypass intrusion zones, report emergencies, etc., as described in the subsequent chapters of this manual.



NOTE:

The keys and the LED indicators (except the **Zone** LED indicators) are the same in all types of keypads.

Keypad Types

The ProSYS supports the following types of keypads:

LED Keypad: Communicates information via LEDs (either an 8-LED keypad or a 16-LED keypad).

LCD Keypad: Communicates the system status via messages displayed on an LCD.

LCD Proximity Keypad: An LCD keypad with the ability to sense when a proximity key tag is near it. This type of keypad provides the user with a friendly and easy way to arm or disarm the security system. Refer to *Chapter 12, Proximity Key*, page 55.



NOTE:

For information regarding the Touchscreen keypad, refer to the ProSYS Touchscreen Keypad Instruction manual that is included with the product.

LED Indicators

The six LED indicators found at the upper left provide typical system indications, as discussed below. Some indicators have additional functions, which are explained later on.



NOTE:
If required, the system status can be hidden by setting the keypad to *Hidden LCD* mode. In this mode, the **Arm/🔒**, **Ready/✓** and **Bypass/↪** LEDs do not function, and the LCD displays **ENTER CODE:** After entering a valid user code, the system works in and displays the *Normal Operation* mode. One minute after the last operation, the system automatically switches to *Hidden LCD* mode.

Power/🔌 LED

The **Power/🔌** LED indicates system operation.

Condition	Description
ON	The system is operating properly from commercial (AC) power; its backup battery is in good condition.
OFF	The system is inoperative due to lack of power (from both commercial AC and backup battery); servicing is required.
RAPID FLASH (about 4 times per second)	Indicates a trouble condition, as described on page 66.
SLOW FLASH (about once every 2 seconds)	Indicates the system is in <i>User Functions</i> mode. See page 55 for more information on user functions.



NOTE:
If a trouble condition exists, the **Power/🔌** LED will flash only when the system is in its disarmed state. Once the system is armed, a previously flashing **Power/🔌** LED will light steadily.

Arm/🔒 LED

The **Arm/🔒** LED indicates whether or not the system's intrusion detectors are armed.

Condition	Description
ON	The system's intrusion detectors are armed; subsequent violations of a protected point or area (e.g. a door, a window, unauthorized motion) will result in a burglar alarm
OFF	The intrusion function of the system is disarmed.
SLOW FLASH (about once every second)	Indicates the system is in its Exit Delay time period.
RAPID FLASH (about 4 times per second)	Indicates an alarm condition, and occurs after disarming an alarmed system while the display is in <i>Alarm Memory</i> mode. To restore the display to <i>Normal Operation</i> mode, press  .

Ready/✓ LED

The **Ready/✓** LED indicates whether or not the system's intrusion zones are secured and ready to be armed.

Condition	Description
ON	All intrusion zones are secure; the system is ready to be armed.
OFF	One or more intrusion zones are not secure, and the system is not ready to be armed. Before the system can be armed, the condition must be addressed. -OR- For 3 minutes when power is restored to an unpowered system (if defined by your installer).
SLOW FLASH	Indicates the system is ready to be armed while a specially designated entry/exit door remains open.

Bypass/ LED

The **Bypass/ ** LED is normally lit when *Stay* mode is selected.

Condition	Description
ON	At least one intrusion zone is bypassed, or <i>Stay</i> mode is selected.
OFF	All zones are operating normally and the system is in <i>Arm</i> mode.

Fire/ LED

When lit, the **Fire/ ** LED indicates that the system is experiencing a fire alarm. When flashing, a problem has been detected on the fire circuit, and must be serviced.

Condition	Description
ON	A fire alarm or fire emergency is in progress or has recently occurred.
OFF	All fire zones are operating normally.
FLASHING	A problem has been detected on the fire circuit and must be serviced.

Tamper/ LED

The **Tamper/ ** LED indicates that a zone, a keypad, or an external module has been tampered with and requires resetting. In some cases, a technician code is required to restore the system to *Normal Operation* mode.

Condition	Description
ON	A zone, keypad, or an external module used by the system has been physically disturbed or tampered with. If disarmed without fixing the problem, only the sound will be silenced.
OFF	All zones are operating normally.

Zone LEDs

The **Zone** LEDs indicate the status of each of the system's intrusion zones. For LCD keypads, the display indicates the zone's number and label.

Condition	Description	
	System Disarmed	System Armed
ON	N/A	An alarm has occurred in the indicated zone.
OFF	The corresponding zone is secured.	
FLASHING	The indicated zone is not secured.	N/A

Keys

The keys on the keypad can be used for a variety of functions. Each key is explained below.

Numerical Keys

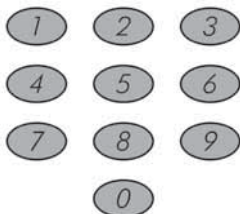







Numerical keys are used to input the numeric codes that may be required for arming, disarming, and triggering emergency alarms, along with several other special functions.

Function Keys (A, B, C and D)

By default, Function keys are used to arm groups of zones, as defined by your installer and described on page 24. Function keys can also be used to activate a prerecorded series of commands, as described on page 52.

Control Keys

The functions of the control keys on the keypad vary according to the mode being used. The following table lists the functions of the keys in *Normal Operation* mode and when using the **User Functions** menu:



Key	Normal Operation	User Functions
	Activates the <i>User Functions</i> mode.	Exits from the current menu and returns to Normal Operation mode.
	Activates the Away mode, Group Arming and Quick Arming.	Changes data.
	Activates the Stay mode and Quick Arming.	Changes data.
	Disarms the system after the user code is entered.	Terminates commands and confirms data to be stored.
	Provides the system status.	Scrolls up a list/moves the cursor to the left.
	Bypasses zones and provides information on bypassed zones (must be pressed after entering a user code).	Scrolls down a list/moves the cursor to the right.

Emergency Keys

Your keypad provides three sets of emergency keys, which can be pressed whenever the police, fire department, or auxiliary assistance is required.



Police Emergency



Pressing  and  simultaneously, and for at least two seconds, will activate a Police Emergency alarm (Panic alarm).



Fire Emergency



Pressing  and  simultaneously, and for at least two seconds, will activate a Fire Emergency alarm.



Auxiliary Emergency



Pressing  and  simultaneously, and for at least two seconds, will activate an Auxiliary Emergency alarm.

The annunciation that results during these emergency alarms, along with other system sounds, is described on page 68. If your system has been programmed to do so, it will communicate any or all of these alarms to the Monitoring Station monitoring your installation. System programming also determines whether these emergency alarms will be audible and/or capable of being communicated to the Monitoring Station.

Quick Key Operation

The Quick Key Operation is a short effective way that helps you to easily operate your system and quickly activate user functions, skipping the user code. For example, to set the system, simply press the  /  key.



NOTE:

For quick key operation your installer has to define quick key operation.

LCD Status Display

The LCD status display will vary depending on the number of partitions in your system.

If your system is defined with only one partition, the LCD displays the partition name, time and date.

If your system has 2 or 3 partitions, the LCD displays the system name, date, time and the status of each partition. A status letter represents the partition's status, as follows:

A: Partition Armed **N:** Partition Not Ready **L:** Partition in Alarm
S: Partition Stay Armed **R:** Partition Ready

LCD Blank Display

If defined by your installer two minutes after the last keypad operation the keypad will be disabled and the following display will appear on the LCD:

Enter code:

—

To release the keypad and return to normal operation mode press: **[CODE]**

+  / 



NOTE:

During Blank Display mode the Ready LED indicates a fault in the system.

Chapter 3: Arming and Disarming the System

Arming

Arming your system enables its intrusion detectors to trigger an alarm when violated. Remember, *fire protection* and the protection offered by the keypad's *emergency keys* are *always* armed and always available.

Your ProSYS offers the following kinds of arming:

- ◆ **Away**, page 20
- ◆ **Stay**, page 21
- ◆ **Partition**, page 22
- ◆ **Group**, page 24
- ◆ **Quick**, page 24
- ◆ **Force**, page 25
- ◆ **Wireless Button**, page 25
- ◆ **Proximity Tag**, page 25
- ◆ **Keyswitch**, page 25
- ◆ **Access Control**, page 25

Away Arming

Away arming prepares *all* of the system's intrusion detectors to sound an alarm, if violated, and is used when leaving the premises empty.



➤ To away arm:

- 1) Check the **Ready/✓** LED on your keypad. If it is lit or flashing, the system is READY to be armed.

If the **Ready/✓** LED is NOT lit or flashing, the system is NOT ready to be armed. In this case, secure or bypass the violated zone(s), see page 30, and then proceed.

- 2)

THE JONESES 05:42 DEC 16 TUE

 Hold the tag close to the keypad's keys or enter your user code and press  /  .

NOTE:

If you make a mistake, the keypad produces three short beeps. If so, press



quickly and re-enter the above sequence correctly.

3)



All persons are to exit except the person arming the system. Leave the premises and close the door.

The keypad beeps and the **Arm/**  LED flashes while the system counts down the Exit Delay time period (shown in the bottom right of the LCD).





When the Exit Delay time period is up, the **Arm/**  LED lights steadily.



Stay Arming

Stay arming activates only external detectors, enabling individuals to remain inside and move about the premises even after the system is armed.

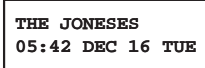

➤ To stay arm:

- 1) Check the **Ready/**  LED on your keypad. If it is lit or flashing, the system is **READY** to be armed.



If the **Ready/**  LED is NOT lit or flashing, the system is NOT ready to be armed. In this case, secure or bypass the violated zone(s), as described on page 30, and then proceed.

- 2)  Hold the tag close to the keypad's keys or enter your user code and press  / .

NOTES:

Press  /  twice to cancel the Entry Delay time period.

Press  during the Exit Delay time period to silence the beeps from the keypad.

If you make a mistake entering your user code, the keypad produces three short beeps. If so, press   quickly and re-enter the above sequence correctly.

3)

THE JONESES
HOME: EXIT = 0:45

If required, leave the premises and close the door.

During the Exit Delay time period, the keypad beeps, the **Arm/🔒** LED flashes, and the **Bypass/↪** LED lights, indicating that the interior zones are being bypassed.

THE JONESES
AT HOME ARMED

When the Exit Delay time period is up, the **Arm/🔒** LED lights steadily.

Partition Arming

One of the ProSYS advantages is its ability to divide any system into a number of partitions. Each partition may be viewed as a separate security system, each of which can be armed and disarmed individually regardless of the condition of the other.

Partitions can be armed/disarmed one at a time, or all at once, and can be Stay or Away armed.

Keypads and Partitions - Each keypad is assigned to different partition(s). The Grand Master and the Manager (with access to all partitions) can use any keypad to access any partition. Other users can use only designated keypads.

Common Zones - Partitioned systems have to share common zones. For example, a shared front door to two family houses must be available to both families and is therefore shared between them.

A common zone(s) is armed only if all partitions sharing the zone(s) are armed. The common zone(s) is disarmed if any of the partitions, to which the zone(s) is assigned, are disarmed.

If the system is defined to work in *Area* mode, the common zone will be armed if any partition sharing the zone is armed. The common zone will be disarmed if all the partitions sharing the zone are disarmed.

Arming Multiple Partitions

Only users that have been defined to operate multiple partitions during the system installation can operate more than one partition and arm/disarm all partitions at once.



➤ To arm multiple partitions:

- 1) Check the **Ready** / ✓ LED on your keypad. If it is lit or flashing, the system is READY to be armed.

If the **Ready** / ✓ LED is NOT lit or flashing, the system is NOT ready to be armed. In this case, secure or bypass the violated zone(s), as described on page 30, and then proceed.

- 2)

THE JONESES 05:42 DEC 16 TUE

 Enter your user code and press  /  .



- 3)

ARM R - 0) ALL ↓

 Select the number of the partition you want to arm.

-OR-

Select **0** to arm ALL partitions.

- 4) Press  /  to arm the selected partition(s).
- 5) Repeat the above steps to arm additional partitions.

Examples:

- ◆ To arm partition 3 with code 1234:

1-2-3-4  /  [3]  / 

- ◆ To arm ALL partitions:

1-2-3-4  /  [0]  / 

- ◆ To arm partitions 3 and 4:

1-2-3-4  /  [3] [4]  / 

- ◆ To arm partition 3 in *Stay* mode:

1-2-3-4  /  [3]  / 

Group Arming

Group arming enables you to arm a number of zones within a partition, using the Function keys. Ask your installer about defining groups.

➤ To arm a group (if the system has one partition):

- 1) Enter your code, followed by the Function key corresponding to the group(s) you want to arm. The selected group is armed.

For example, to arm Group A, enter: **[Code] [A]**.

- 2) To arm another group, repeat step 1.

➤ To arm a group (if your user code is assigned to more than one partition):

- 1) Enter your user code, then the group letter, then the partition number, and the group letter again.

For example, to arm Group A, enter:
[Code] [A] [Partition No] [A].

- 2) To arm another group, repeat step 1.

NOTE:

If your system has Quick Arming, press the Function key corresponding to the group(s) you want to arm. The selected group(s) is armed.

Quick Arming



Quick arming enables you to quickly arm the system with the press of a key.



NOTE:

Quick Arming should be defined by your installer.

➤ To quick arm using away arming:

- ◆ Hold the tag close to the keypad's keys or press  /  .
The system is fully armed.

➤ To quick arm using stay arming:

- ◆ Hold the tag close to the keypad's keys or press  /  .
The system's external detectors are activated.

➤ To quick arm a group:

- ◆ Press the Function key corresponding to the group(s) you want to arm. The selected group(s) is armed.

Force Arming

Force arming arms the system regardless of open zones. Your installer must enable this option.



WARNING:

Force arming the system results in leaving partition(s) unsecured.

Wireless Button Arming

The system can be armed using a button on a wireless button key. Your installer programs this option. Refer to the instructions supplied with your 4-button key for more information.

Proximity Tag Arming

If your system is appropriately equipped, it can be armed using a proximity tag. Your installer programs this option.

Keyswitch Arming

If your system is equipped with a special keyswitch, it can, with the twist of a key, be toggled through *Arm (Away)* and *Disarm* modes.

Access Control Arming

If your system is equipped with RISCO Group's Access Control, you can arm and disarm the system from the Access Control reader. Refer to the *Access Control User's Manual* for more information.

Disarming

Disarming your system deactivates its detectors. Remember, *fire protection* and the protection offered by the keypad's *emergency keys* are *always* armed and always available.



Your ProSYS offers the following kinds of disarming:

- ◆ **System**, below
- ◆ **Silencing an Alarm**, page 26
- ◆ **Partition**, page 27
- ◆ **Duress**, page 28
- ◆ **Fire Alarm**, page 29

Disarming the System

Disarming deactivates all detectors in the system.

➤ To disarm the system:

- 1) If outside the premises, open an "entry" door. The keypad(s) beeps, indicating that the Entry Delay time period has begun.
- 2) Before the Entry Delay time period expires, enter your user code and press  / .



NOTE:



If you make a mistake when entering your user code, the keypad will produce three short beeps. If so, re-enter the sequence correctly.

Silencing an Alarm

The system is disarmed when an alarm is silenced.

➤ To silence an alarm:

- 1) If outside the premises, open an "entry" door. The keypad(s) beeps, indicating that the Entry Delay period has begun.
- 2) Observe the keypad. If any of the following conditions is evident, an alarm has occurred:
 - ◆ For an LED keypad:
 - ❖ The **Arm**/ LED is flashing.
 - ❖ A **Zone** LED is lit steadily.
 - ❖ The **Fire**/ LED is lit steadily.

- ◆ For an LCD keypad:
 - ❖ The **Arm/🔒** LED is flashing, and the display shows the disturbed zone.
- 3) Enter your user code and press  . If an alarm occurred, the **Arm/🔒** LED and the corresponding **Zone** LED will flash for the Alarm Memory period of about 60 seconds.
 - 4) If you are using an LCD keypad, scroll through the list of alarmed zones.
 - 5) (Optional) To exit the *Alarm Memory* mode before the timeout has expired, press .



NOTES:

It is recommended to leave the premises. Only after police investigation should you consider that the burglar is no longer on your premises and you can re-enter.



In special cases (if programmed so during installation), arming the system after an alarm requires a technician code. On the LCD, a **Not ready - technician reset** message will appear.



IMPORTANT:

If the alarm was caused by a tripped smoke detector(s), the keypad's **Fire/🔥** LED will remain lit, providing an indication that the fire system must be reset before it will be capable of detecting subsequent alarms. Furthermore, until it is reset, you will be prevented from arming your system.



To reset a smoke detector, press [] [2] [2] [user code] [] .

Press [] [] to exit the *User Functions* mode.

Partition Disarming

Partition disarming enables you to disarm individual partitions within an armed system.

➤ **To disarm partitions:**

1) Enter your user code and press  .



2) Select the partition number (1-8).

-OR-













To disarm all partitions at once, select **0**.

-OR-

For an LCD keypad, scroll with the  /  or the  /  key to the required partition (or enter the partition's number).

- 3) Press  /  to confirm. A confirmation message will be displayed for several seconds.
- 4) Repeat the above steps to disarm other partitions.

Examples:

- ◆ To disarm partition 3 with code 1234:
1-2-3-4  /  [3]  / 
- ◆ To disarm ALL partitions:
1-2-3-4  /  [0]  / 
- ◆ To disarm partitions 3 and 4:
1-2-3-4  /  [3] [4]  / 



NOTES:

ALL partitions relate to all partitions that are authorized by the *security code* in use.

If the **Arm** /  LED is flashing after disarming, check the display for activated (armed) zones before proceeding.

Duress Disarming

If you are ever coerced into disarming your system, you can comply with the intruder's wishes while sending a silent duress alarm to the Monitoring Station. To do so, you must use a special duress code, which when used, will disarm the system in the regular manner, while simultaneously transmitting the duress alarm.

To use a duress code, add **1** to the last digit of your user code, as shown in the table below:

User Code	Duress Code
1-2-3-4	1-2-3-5
5-6-7-8	5-6-7-9
6-7-8-9	6-7-8-0

Under no circumstances must the duress code be used haphazardly or without reason. Monitoring Stations, along with Police Departments, treat duress codes very seriously and take immediate action.

➤ **To disarm using a duress code:**

- 1) If outside the premises, open an "entry" door. The keypad(s) beeps, indicating that the Entry Delay time period has begun.
- 2) Enter your duress code and press  . The system is disarmed, and a silent alarm is sent to the Monitoring Station.

Disabling the Fire Alarm (Switch Auxiliary)

Disarming the fire alarm interrupts the power supplied to the system's smoke detector(s) for a predetermined interval, thus resetting and "reading" them for subsequent alarms.



NOTE:

You may need to perform this procedure several times in order to prevent the smoke detector(s) from re-detecting any remaining smoke.

➤ **To disable the fire alarm:**

- 1)

USER FUNCTIONS: 1) BYPASS

 From the **User Functions** menu, select **[2] Activities**.
- 2)

ACTIVITIES: 1) UTIL OUTPUT

 Select **[2] Switch Auxiliary**.
- 3)

INSERT CODE:

 Enter your user code.

DONE HIT ANY KEY

 The fire alarm is disabled for a predefined amount of time.

Chapter 4: Zone Bypassing

[*] [1] [CODE] [#] [1]

When an intrusion zone is not secured, the keypad's **Ready/✓** LED will not light, nor can the system be readily armed. Bypassing a zone enables you to arm a partition even if a zone within that partition is open/not secured.



You may want to bypass a zone when access is needed to one zone in an otherwise protected area, or to cause the system to temporarily circumvent a zone containing damaged wiring until repairs can be made.



WARNING:

A bypassed zone may reduce the system's security capability.

Before performing the following procedure, identify the violated zone(s) as follows:

- ◆ **LED Keypad:** Note which zone LED(s) is flashing on the keypad.
- ◆ **LCD Keypad:** Enter your user code followed by  / , and then scroll down with the down arrow key to view all "not ready" zones. The LCD only displays "not ready" zones that belong to the user code that was entered.

➤ **To change a zone's bypass status:**

- 1)  Enter your code and press  / . The **Bypass/**  LED is illuminated.

NOTE:

If you make a mistake when entering your user code, the keypad will produce three short beeps. Re-enter if necessary.

- 2)  Enter the zone number.

Entering the zone number a second time un-bypasses it (toggle action).

An additional zone(s) can be bypassed at the same time by adding its number to the sequence. For example, to bypass zones 2 and 13 using code 1234, enter:

1-2-3-4  /  02 13  / 

To un-bypass zone 2 only using code 1234, enter:

1-2-3-4  /  02  / 

- 3) When finished entering zone numbers, press

 / .

NOTES:

All zones are automatically un-bypassed when the system is armed and then disarmed again.

The **Bypass** /  LED turns off when arming in *Away* mode.

Chapter 5: Activating Home Appliances (UOs)

[*] [2] [CODE] [#] [1]

You can place a household appliance, such as heating, lighting or an external device, under the control of the ProSYS, where it can be conveniently turned on and off automatically, or by user commands from any system keypad.

There are two types of appliances, each of which behaves differently when activated:

- ◆ **Latched appliance:** Remains activated until it is deactivated.
- ◆ **Pulsed appliance:** Remains activated for a predefined time, after which it is automatically deactivated.

Ask your installer which of your appliances are defined as latched and which are defined as pulsed.



NOTES:

The UO option applies to UOs that are defined as Follow Code. Ask your installer for details about defining UOs in this way.

The default system label for a UO is **OUTPUT**. Ask your installer to define a name, such as **HEATING** for each UO.

Home appliances can also be remotely activated and deactivated by using the Voice module. Refer to the *Voice Module Programming and Installation Manual* for more information.

There are two ways in which to activate home appliances from the keypad:

- ◆ From the **User Functions** menu, as described on page 33.
- ◆ By entering a code, as described on page 33.

Activating Home Appliances from the User Functions Menu

Home appliances can be activated by any user who is assigned a code that is authorized to activate home appliances.

➤ **To activate home appliances from the User Functions menu:**

1)

USER FUNCTIONS: 1) BYPASS

 From the **User Functions** menu, select **[2] Activities**.

2)

ACTIVITIES: 1) UTIL OUTPUT

 Select **[1] Utility Outputs**.

3)

INSERT CODE:

 Enter your user code.

NOTE:

Your installer can define the system so that a user code is not required.

4)

ACTIVATE UO: 01) OUTPUT 01

 Select the number of the utility output that you want to activate or deactivate.

ACTIVATE UO: OUTPUT ACTIVATED

 The selected utility output is activated.

Activating Home Appliances by Entering a Code

Users with the Authority Level of **UO Only** can activate home appliances by entering their user code followed by

#

Disarm /

#/6

. The status of all UOs assigned to this code is subsequently changed.

Chapter 6: Setting Follow Me Destinations

[*] [2] [7] [CODE] [#]

In the case of an alarm or event, the system can initiate a phone call to a designated telephone or pager, send an SMS/email and employ unique tones or messages to express the active event.

Your installer defines the type of reporting to a follow me destination. Consult your installer for the possibility to report events by SMS or Email.

➤ To enter/edit a Follow Me destination:

- 1)

USER FUNCTIONS: 1) BYPASS

 From the **User Functions** menu, select **[2] Activities**.
- 2)

ACTIVITIES: 1) UTIL OUTPUT

 Select **[7] Follow Me**
- 3)

INSERT CODE:









 Enter your user code.
- 4)

DEFINE FM: 01) FM No. 01

 Select the FM index number you want to define.
- 5)

EDIT FM NO:01

 Enter the phone number, including the area code (if required) or email address.

To enter an email address, use the  /  and  /  keys to obtain the required characters and use the  /  and  /  keys to move to the required character position in the address.

NOTE:

Whether you can enter a phone number or an email address depends on the follow me type defined for the index by your installer.

If you entered a phone number, two questions are displayed. These questions enable you to define the permission assigned to the designated phone when the Advanced Voice Module is connected to the system. FM phone numbers can also be used for remote operation. Refer to the *Voice Module Programming and Operations Manual* for more information.

6)

ENABLE FM NO 1:
REMOTE PROGRAM:N

Select one of the following options to define the permission:

Y: The user on the FM phone can enter the **Remote Operations** menu and perform arm, disarm, zone bypassing, home appliance activation, FM phone editing, and remote listen and talk operations.

N: The user on the FM phone cannot enter the **Remote Operations** menu.

7)





ENABLE FM NO 1:
REMOTE LISTEN:N

Select one of the following options to define the permission:

Y: The user on the FM phone can perform remote listen in and talk operations from the **Acknowledgement** menu.

N: The user on the FM phone cannot perform listen and talk operations from the **Acknowledgment** menu. Refer to the *Voice Module Programming and Operations Manual* for more information.

If required, when defining a telephone number (maximum 32 digits), include the special functions described below to achieve the related effect.

You can press the  /  or  /  keys to toggle to the required character.

Function	Sequence	Results
Stop dialing and wait for a new dial tone.	[*] [1]	A
Wait a fixed period before continuing.	[*] [2]	B
Switch from <i>Pulse</i> to <i>Tone</i> (or from <i>Tone</i> to <i>Pulse</i>).	[*] [3]	C
Send the DTMF * character.	[*] [7]	*
Send the DTMF # character.	[*] [9]	#
Delete numbers from the cursor position.	[*] [0]	



NOTE:

To delete a number, place the cursor in the first position and press [*] [0].

When done with your complete entry, press  /  to store it.

Chapter 7: User Codes

[*] [5] [CODE] [#] [1]

To perform many of the ProSYS's functions, a security code (often called a user code) must be entered at the keypad.

Each individual using the system is assigned a user code, which, in turn, is linked to an Authority Level. Those with a "higher authority" have access to a greater number of system functions, while those with a "lower authority" are more restricted in what they may do. There are eight different Authority Levels available for users of the ProSYS, as described on page 38.

Note that user codes may have variable lengths up to 6 digits, according to your installer's definition, as follows:

- ◆ ProSYS 128 systems can support up to 99 different user codes.
- ◆ ProSYS 40 systems can support up to 60 different user codes.
- ◆ ProSYS 16 systems can support up to 30 different user codes.

Your ProSYS was given a Grand Master Code of **1-2-3-4** during manufacturing. Unless your installer has already changed it to suit your preference, it's best to modify this code to one that is unique and personalized. To change the *Master Code*, and/or to set up *user codes*, follow the procedure in the following section.

Setting and Changing User Codes

[*] [5] [CODE] [#] [1]

The user assigned the Grand Master Authority Level can change all user codes but cannot view the digits in the user codes. Users with other Authority Levels can only change their own codes.

The system must be disarmed in order to set or change user codes.

➤ To set/change a user code:



- 1)

USER FUNCTIONS: 1) BYPASS

 From the **User Functions** menu, select **[5] Access Code**.

- 2)

INSERT CODE:

 Enter your 4-digit or 6-digit Master or Grand Master code, and press  / .

- 3)

ACCESS CODE: 1) UPDATE CODES

 Select **[1] Update Code.**

- 4)

CODE 1234 GRAND 00) USER 00

 Enter the two-digit User Index number to which you want to assign a user code.

For example, to assign a user code to user index number **6**, press **[0] [6]**.

NOTES:

In ProSYS 128 systems, the User Index number is from **00** to **98**.



In ProSYS 40 systems, the User Index number is from **00** to **59**.

In ProSYS 16 systems, the User Index number is from **00** to **29**.

The User Index number **00** belongs to the Grand Master user code.

- 5)

CODE 06, USER ENTER: 0

 Enter a four/six digit code and press  .

- 6)

CODE: 06, MSTR ACCEPTED

 If successful, a single confirmation beep is sounded, and a message is displayed. If not, three quick error beeps are sounded.

- 7)

SELECT CODE: 07) 0 USER

 Repeat the above steps for additional codes until complete.

- 8) When all codes are entered press   quickly to reset and exit the **User Functions** menu.

Deleting User Codes

At times, it may be desirable to completely delete a *user code*. Note that it is impossible to delete the *Master Code* (although it can be changed).

The system must be disarmed in order to delete user codes.

➤ **To delete a user code:**

- 1) Follow steps 1-3 in the previous procedure.

- 2)



CODE 1234 GRAND 00) USER 00

 Enter the two-digit User Index number for which the code is to be deleted.

For example, to delete the user code assigned to user index number **6**, press **[0] [6]**.

- 3)



CODE 06, USER ENTER: 6543

 Press **[0]** followed by  / .
- 4)

CODE: 06, USER ACCEPTED

 If successful, a single confirmation beep is sounded, and a message is displayed. If not, three quick error beeps are sounded.
- 5)

SELECT CODE: 07) 0 USER

 Repeat the above steps for additional codes until complete.
- 6) When all required codes are deleted, press   quickly to reset and exit the **User Functions** menu.

User Authority Levels

[*] [5] [CODE] [#] [2]

Each individual using the system is assigned a user code, which, in turn, is linked to an Authority Level. Those with a "higher authority" have access to a greater number of system functions, while those with a "lower authority" are more restricted in what they may do. There are nine different Authority Levels available for users of the ProSYS.

Level	Description
GRAND MASTER	All operations for all partitions. There is only one Grand Master code in the system, and it is designated to user index number 00 . This code can be changed by the installer or the Grand Master.
MANAGER	All operations for all partitions. There is only one Manager code in the system, and it is designated to user index number 01 .
MASTER	All operations but only for designated partitions. The user holding the Master code can change the Master code and the codes of all Authority Levels lower than Master. There can be any number of Master codes in the system.
USER	Only basic operations for one or more partitions.
ARM ONLY	Arming one or more partitions. Arm Only codes are useful for workers who arrive when the premises are already open but, because they are the last to leave, they are given the responsibility to close the premises.

Level	Description
MAID	Used only for one-time arming and disarming, after which the code is automatically erased and should be redefined. This code is typically used residentially for maids, home attendants, and repairmen who must enter the premises before the owner(s) arrive.
UNBYPASS	Basic operations to one or more partitions without the ability to bypass zones.
GUARD	Typically used to enable a guard to disarm the system for a predefined amount of time. After this time, the system is automatically armed again.
UO ONLY	Typically used to enable the operation of a device controlled by a Utility Output (meaning a door and so on). These codes are used only to operate a Utility Output.

Entering User Labels



[*] [5] [CODE] [#] [4] - Installer or Grand Master

You can rename the labels that identify users by changing the default labels (User 1, User 2, and so on) to the names of the users themselves.

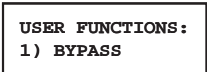
➤ To enter a user label:

- 

From the **User Functions** menu, select **[5] Access Code**.
- 

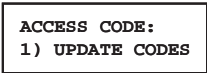
Enter your 4-digit or 6-digit Master or Grand Master code and press  / .
- 

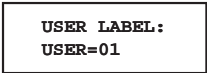
Select **[4] User Label**.
- 

Select the index number of the user code that you want to label, and enter a name for the selected user, as described in the character table on page 40.

Character Table











Use the keys on the keypad to produce characters according to the table below. Pressing a particular key toggles between the characters available for that key. The ProSYS permits a total of 74 characters (letters, numbers, and symbols) for use in labeling.



NOTES:

The data sequence of each key in the following table is suitable only for the English version.

You can use a maximum of 10 characters per user label.

KEY	DATA SEQUENCE													
1	1	A	B	C	D	E	F	G	H	I	J	K	L	M
2	2	N	O	P	Q	R	S	T	U	V	W	X	Y	Z
3	3	!	"	&	'	:	-	.	?	/	()		
4	4	a	b	c	d	e	f	g	H	i	j	K	l	m
5	5	n	o	p	q	r	s	t	U	v	w	X	y	z
6 - 0	Each of these keys toggles between producing their number and a blank space.													
 	Use this button to toggle forward through the available characters.													
 	Use this button to toggle backward through the available characters.													
 	Use this button to move the cursor to the left.													
 	Use this button to move the cursor to the right.													
 	Use this button to enter a completed label into the system.													

Assigning Double Codes

[*] [5] [CODE] [#] [7]

Double codes are a high-security option that ensures that the system is disarmed only by pairs of users. This prevents individual users from disarming the system alone, by making their user code active only if accompanied by their partner's user code. The time between entering the two user codes is 60 seconds.



NOTES:

Your installer must enable the Double Code feature.

The Authority Levels of **Maid**, **Arm Only** and **Guard** cannot be used to perform Double Code disarming.



➤ To assign double codes:

- 1)

USER FUNCTIONS: 1) BYPASS

 From the **User Functions** menu, select **[5] Access Code**.
- 2)

INSERT CODE:

 Enter your user code, followed by  / .
- 3)



ACCESS CODE: 1) UPDATE CODES

 Select **[7] Double Codes**.
- 4)

DOUBLE CODE: 01) 00 WITH 00

 Select the index number of the double code that you want to assign.
- 5)

DOUBLE CODE 01: 1st=00 2nd=00

 Enter the user index numbers of the users you want to pair together for the double code, and press  / .





Chapter 8: Viewing Trouble Conditions

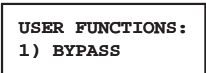

[*] [3] [1] [CODE] [#]

A rapid flashing of the **Power/⏻** LED indicates a trouble condition. The following procedure describes how to identify the trouble condition. Refer to the table on page 66 for a list of possible trouble conditions and their descriptions.

The system must be disarmed to view trouble conditions.

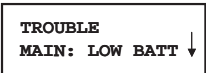
➤ **To view trouble conditions:**

- 1)  From the **User Functions** menu, select **[3] View**.
- 2)  Select **[1] Trouble**.
- 3)  Enter your user code and press  / . The first trouble condition is displayed.
- 4)  If a (↓) appears, other troubles exist. Scroll down to view the next ones.

For an LED keypad, select the View/Trouble function by pressing **[3] [1] [USER CODE]  / **. The **Zone** LEDs flash according to the trouble(s).



NOTE:

In some cases, you may be able to correct troubles and restore the system to *Normal Operation* mode yourself. In other cases, your dealer (or other related services) may be required. When all outstanding troubles are resolved, the rapidly flashing **Power/⏻** LED on your keypad(s) lights steadily, and all evidence of the troubles is automatically removed from your system.

Chapter 9: Setting and Changing System Time and Date

[*] [6] [CODE] [#] [1] / [2]

The correct time and date must be set to ensure proper operation of the ProSYS.

Setting and Changing System Time

The system time is set and changed from the **Set Clocks** menu.

➤ **To set/change the system time:**

- 1)

USER FUNCTIONS: 1) BYPASS

 From the **User Functions** menu, select **[6] Clocks**.
- 2)

SET CLOCKS: 1) SYSTEM TIME

 Select **[1] System Time**.
- 3)

INSERT CODE:

 Enter your user code.
- 4)

ENTER SYS TIME: 00:31

 Enter the correct time in 24-hour format.

Setting and Changing System Date

The system date is set and changed from the **Set Clocks** menu.

➤ **To set/change the system date:**

1)

USER FUNCTIONS: 1) BYPASS
--

 From the **User Functions** menu, select **[6] Clocks**.

2)

SET CLOCKS: 1) SYSTEM TIME

 Select **[2] System Date**.

3)







INSERT CODE:

 Enter your user code.

4)

ENTER SYS DATE: JAN 3 (2003) FRI
--

 Enter the correct date.

Use the  /  and  /  keys to move the cursor and the  /  key to toggle among the choices.

Chapter 10: Defining Weekly Schedules

[*] [6] [CODE] [#] [5]

Defining weekly schedules enables you to automate some system operations. This is performed by defining up to two time intervals per day, during which the system automatically performs one of the following functions:

- ◆ **Automatic Arming/Disarming**, below
- ◆ **Automatic UO Activation**, page 48
- ◆ **User Limitation**, page 50

You can define automatic time intervals for every day of the week, or individual days of the week. When performing this procedure, use the data that you prepared in the table provided in *Appendix C: Scheduling Tables*, page 70.

In some cases, it may be necessary to temporarily disable the automatic scheduling. Each of the schedules contains an off/on parameter to quickly perform this when needed.

Automatic Arming/Disarming

An arming schedule automatically arms and disarms the system during your required time intervals.

When defining the automatic arming/disarming schedule, you need to define the following parameters: **On/Off**, **Partition**, **Arming Mode**, **Time**, and **Label**.

➤ To define an automatic arming/disarming schedule:

- 1)

USER FUNCTIONS: 1) BYPASS

 From the **User Functions** menu, select **[6] Clocks**.
- 2)

INSERT CODE:

 Enter your user code.
- 3)

SET CLOCKS: 1) SYSTEM TIME

 Select **[5] Scheduler**.

- 4)

SCHEDULER: 01) SCHEDULE 01

 Select a program.
- 5)





SCHEDULE 01: 01) ARM/DISARM

 Select **[1] Arm/Disarm**.
- 6)



ARM/DISARM s:01 1) ON/OFF ↓

 Select **[1] On/Off**.
- 7)

SCHEDULE 01: SCHEDULE: <u>ON</u>

 Use the  /  key to define :
On : Automatic scheduling is enabled.
Off : Automatic scheduling is disabled.
Press  / .
- 8)



ARM/DISARM s:01 1) ON/OFF ↓

 Press  / .
- 9)

ARM/DISARM s:01 2) PARTITION

 Select **[2] Partition**.
- 10)

P:12345678 s:01 Y-----

 Use the  /  key to enter Y under each partition that will be automatically armed and disarmed.
- 11)



ARM/DISARM s:01 3) ARMING MODE

 Select **[3] Arming Mode**.
- 12)

ARMING MODE: s:01 1) AWAY

 Select one of the following options:
[1] Away: To fully arm the system. Proceed to step 14.
[2] Stay: To arm the system's external detectors. Proceed to step 14.
[3] Group: To arm groups within the assigned partitions. Proceed to step 13.
- 13)

GROUP=ABCD s:01

 Use the  /  key to enter Y under each group that will be automatically armed and disarmed.

- 14)

ARM/DISARM	S:01
4) DAY/TIME	

 Select **[4] Day/Time.**
- 15)

SELECT A DAY
1) MONDAY

 Select **[1] Monday.**
-OR-
Select **[8] All** to set the same time intervals for every day in the week.
- 16)

MON:ARM1	S:01
00:00	

 Enter the first time at which the system is armed on Monday.
- 17)

MON:DISARM1	S:01
00:00	

 Enter the first time at which the system is disarmed on Monday.
- 18)

MON:ARM2	S:01
00:00	

 Enter the second time at which the system is armed on Monday.
- 19)

MON:DISARM2	S:01
00:00	

 Enter the second time at which the system is disarmed on Monday.

NOTE:

Leave the time at 00:00 if you do not want to perform the automation during the current interval for the current day.

- 20)

SELECT A DAY
2) TUESDAY

 Define intervals for Tuesday and the rest of the week, as described in steps 16-19 above.
After you have defined the last day or all days in the week, you define a label for the weekly program.
- 21)

ARM/DISARM	S:01
5) LABEL	

 Select **[5] Label.**
- 22)

SCHEDULE LABEL:
SCHEDULE 01

 Enter a name for the scheduling program, as described in the table on page 40.
- 23)

SCHEDULER:
02) SCHEDULE 02

 Define additional scheduling programs, as required.

Defining a UO Activation Schedule

A UO (home appliance) activation schedule automatically activates and deactivates UOs during your required intervals.

In each schedule, you can define four UOs to operate simultaneously.

When defining a UO activation schedule, you need to define the following parameters: **On/Off**, **UOs**, **Time Schedule**, **Vacation**, and **Label**.

➤ To define a UO activation schedule:

- 1)

USER FUNCTIONS: 1) BYPASS

 From the **User Functions** menu, select **[6] Clocks**.

- 2)

INSERT CODE:

 Enter your user code.

- 3)

SET CLOCKS: 1) SYSTEM TIME

 Select **[5] Scheduler**.

- 4)

SCHEDULER: 01) SCHEDULE 01 ↓
--

 Select a schedule, other than those already being used for automatic arming or user limitation.

- 5)

SCHEDULE 02: 1) ARM/DISARM

 Select **[2] UO On/Off**.



- 6)



UO ON/OFF S:02 1) ON/OFF

 Select **[1] On/Off**.

- 7)



SCHEDULE 02: SCHEDULE:ON

 Use the  /  key to define :
On : Automatic scheduling is enabled.
Off : Automatic scheduling is disabled.

Press  / .

- 8)

UO ON/OFF S:02 1) ON/OFF

 Press  / .

- 9)

UO ON/OFF S:02 2) UTIL OUTPUTS
--

 Select **[2] Utility Outputs**. In this option, you select the UO that will be operated in this scheduling program.

- 10)

UTIL OUTPUT S:02
01)OUTPUT 01 N

 Specify whether or not the first UO in the list should be automatically activated by using the  key to enter one of the following characters at the end of the second line in the LCD:
Y: Automatically activated.
N: Not automatically activated.
- 11) Specify whether or not the three remaining UOs in the list should be automatically activated by selecting them and following step 7 above.
- 12)

UO ON/OFF S:02
2)UTIL OUTPUTS

 Select **[3] Day/Time**.
- 13)

SELECT A DAY
1) MONDAY

 Define time windows for the week, as described in step 16 on page 47.
- 14)

UO ON/OFF S:02
4)VACATION

 Select **[4] VACATION**. In this option, you define the way in which the group of UOs are activated during a vacation.
- 15)

UO VACATION S:02
YES/NO N

N: During vacation, UOs are activated in the same way as defined in the time windows of the week. Go to step 20.
Y: UOs are activated during the vacation according to the time schedule defined in the next steps (vacation definition).

NOTE:

If all the time intervals during the vacation are defined as **00:00**, then the UOs are not activated during the vacation.

- 16)

VAC: START1 S:02
00:00

 Enter the first time at which the UO is to be activated on vacation.
- 17)

VAC: STOP1 S:02
00:00

 Enter the first time at which the UO is to be deactivated on vacation.
- 18)

VAC: START2 S:02
00:00

 Enter the second time at which the UO is to be activated on vacation.

- 19)

VAC: STOP2 S:02 00:00

 Enter the second time at which the UO is to be deactivated on vacation.
- 20)

UO ON/OFF S:02 5) LABEL

 Select **[5] Label**.
- 21)

SCHEDULE LABEL SCHEDULE 02

 Enter a name for the schedule, as described in the table on page 40.
- 22)

SCHEDULER: 03) SCHEDULE 03

 Define additional weekly schedules, as required.

Defining a User Limitation Schedule

A user limitation schedule automatically prevents certain users from disarming the system during specified time intervals. By default, all users of the system operate without this limitation.

When defining a user limitation schedule, you need to define the following parameters: **On/Off**, **Users**, **Time Schedule**, and **Label**.



NOTE:

By default, all users are not restricted.

➤ To define a user limitation schedule:

- 1)

USER FUNCTIONS: 1) BYPASS

 From the **User Functions** menu, select **[6] Clocks**.
- 2)

INSERT CODE:

 Enter your user code.
- 3)

SET CLOCKS: 1) SYSTEM TIME

 Select **[5] Scheduler**.
- 4)

SCHEDULER: 01) SCHEDULE 01 ↓

 Select a schedule other than those already being used for automatic arming or UO activation.
- 5)

SCHEDULE 03: 1) ARM/DISARM





 Select **[3] User Limit**.

- 6)



USER LIMIT S:03 1)ON/OFF

 Select **[1] On/Off.**
- 7)

SCHEDULE 03: SCHEDULE: <u>ON</u>

 Use the  /  key to define :
On : Automatic scheduling is enabled.
Off : Automatic scheduling is disabled.
Press  / .
- 8)



USER LIMIT S:03 1)ON/OFF

 Press  / .
- 9)

USER LIMIT S:03 2)USERS NUMBER

 Select **[2] Users Number.**
- 10)

USER LIMIT S:03 00)USER 00 N

 Specify whether or not each user in the list should be automatically restricted from disarming the system by using the  /  key to enter one of the following characters at the end of the second line in the LCD:
Y: Automatically restricted.
N: Not automatically restricted.
- 11)

USER LIMIT S:03 2)USERS NUMBER

 Select **[3]Day/Time.**
- 12)

SELECT A DAY 1) MONDAY

 Define time windows for the week, as described in step 16 on page 47.
- 13)

USER LIMIT S:03 2)USERS NUMBER

 Select **[4] Label.**
- 14)

SCHEDULE LABEL: SCHEDULE 03

 Enter a name for the weekly schedule, as described in the table on page 40.
- 15)

SCHEDULER: 04)SCHEDULE 04

 Define additional scheduling programs, as required.

Chapter 11: Programming Function Keys

[*] [9] [CODE] [#] [5]

The ProSYS enables you to record a series of commands and assign them to a Function key. When the Function key is pressed, the recorded commands are executed from beginning to end.



NOTE:
The default function for all Function keys is group arming, as described on page 24.

Before programming a Function key, it is recommended to perform your required series of commands, making a note of every key you press while doing so. These keys will be entered in the form of characters in step 4 of the procedure for programming the Function key.

For example, to arm partitions 1 and 2 in a 3-partitioned system, you would press the following keys in step 4:





This example requires the following sequence of characters:

1234a12a



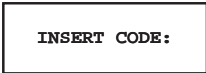

NOTE:
Function keys cannot be programmed to perform disarming commands.

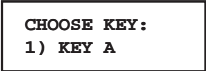
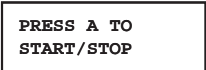
➤ To program a Function key:

- 1)  From the **User Functions** menu, select **[9] Miscellaneous**.
- 2)  Enter your user code.
- 3)  Select **[5] Key Custom**.
- 4)  The **Choose Key** menu lists the four function keys. Select the function key that you want to program.
- 5)  Press **[A]** (or the function key you selected in step 4).

- 6)

KEY A CUSTOM

 Use the numerical keys or the  /  key to enter a series of characters representing your required keys, as described on page 53. Each character you enter is displayed in the second line of the LCD.
- 7)

KEY A CUSTOM 1234a12a

 When you have finished entering the series of characters, ensure that the cursor is placed in the field after the last character in the series, and press **[A]** (or the function key you selected in step 4) again. The series of characters is saved and assigned to the selected function key.

NOTE:





When entering characters, ensure that the cursor is placed after the last character. Otherwise, the last character you defined and everything after it will be erased, and the Function key will not perform the required function.







- 8)

CHOOSE KEY: 1) KEY A





 If required, select an additional Function key to program and repeat the above procedure.



Using the Arm Key to Program Function Keys



In step 4 of the previous procedure, the ,  and ,  keys are used to toggle between and enter characters that represent keys on the ProSYS keypad. The following is a list of these characters and the keys they represent:

Character	Represents
0-9	The Numerical keys from 0 to 9.
A-D	The Function keys from A to D.
a	The  ,  key.
S	The  ,  key.
*	The  key.
#	The  ,  key.

NOTE:

You can also use the Numerical keys to enter numbers when programming Function keys. Use the ,  and ,  keys to move the cursor.

When your required character is displayed, press ,  to move the cursor to the next field in the LCD, where you can enter the next character in the series.

When you have finished entering a series of characters, ensure that the cursor is placed in the field after the last character in the series by pressing ,  again.

Chapter 12: Proximity Keypad

The proximity keypad enables you to use a proximity tag to arm and disarm the security system or to activate and deactivate home appliances and utilities, such as heating and lights.

Proximity tag programming is performed from the **User Functions** menu. When programming a proximity tag, the following three options are available:

- ◆ **(RE)WRITE TAG:** Adds a new proximity tag (described below).
- ◆ **DEL BY USER:** Deletes a proximity tag according to the user serial number, as described on page 56.
- ◆ **DEL BY TAG:** Deletes a proximity tag according to the user tag, as described on page 57.

This section also includes general instructions for using a proximity tag, as described on page 58.



NOTES:

Users can define or delete their individual proximity tags, but the Grand Master can define or delete **any** user's tag.

Each proximity tag can be assigned to only one user.

Adding a New Proximity Tag

You can add a new proximity tag for each user in the system, as required.

➤ To add a new proximity tag:

- 1)

USER FUNCTIONS: 1) BYPASS

 From the **User Functions** menu, select **[5] Access Code**.
- 2)

INSERT CODE:

 Enter your user code.
- 3)

ACCESS CODE: 1) UPDATE CODES
--



 Select **[5] Prox Tag**.
- 4)

PROX TAG: 1) (RE)WRITE TAG

 Select **[1] (Re)Write Tag**.

- 5)

SELECT USER: 00) 0 GRAND

 Select the user to which you want to assign the proximity tag and press  .

NOTE:

A display of (****) indicates that a user has already been assigned to a specific proximity tag.

- 6)

USER XX: APPROACH TAG TO UNIT

 Within 10 seconds, approach the proximity tag at a distance of 3 to 7 cm. from the keypad's keys. The keypad automatically reads the proximity tag and saves it into the system's memory.

Once the proximity tag has been successfully recorded, a long confirmation beep sounds, and a confirmation message is displayed.

If the proximity tag is already stored in the system's memory, the following message is displayed: **USER TAG ALREADY IN MEMORY.**

NOTES:

Once a proximity tag is recorded, it will be functional from all keypads.

The programmed proximity tag has the same permissions that are defined for the specified user code.

If a user is defined as having the **Maid** security level, then the proximity tag can operate only if a security code was previously defined for that user.

Deleting a Proximity Tag By the User Serial Number

You can use this option to delete a proximity tag for which the user is known.

➤ **To delete a proximity tag by user serial number:**

- 1)

USER FUNCTIONS: 1) BYPASS

 From the **User Functions** menu, select **[5] Access Code**.
- 2)

INSERT CODE:

 Enter your user code.
- 3)

ACCESS CODE: 1) UPDATE CODES

 Select **[5] Prox Tag**.

- 4)

PROX TAG: 1) (RE)WRITE TAG

 Select **[2] Del By User**.



- 5)

SELECT USER: 00)0 GRAND

 Select the user for which you want to delete the proximity tag and press  **[/6]**.

- 6)

DELETE ARE YOU SURE? N

 Select **[Y]** or **[N]** by using the   key and then pressing  **[/6]**. If you select **[Y]**, the following confirmation message is displayed: **USER XX: TAG DELETED**.

Deleting a Proximity Tag By the User Tag

You can use this option to delete a proximity tag for which the user is **not** known.

➤ To delete a proximity tag by user tag:

- 1)

USER FUNCTIONS: 1) BYPASS

 From the **User Functions** menu, select **[5] Access Code**.

- 2)

INSERT CODE:

 Enter your user code.

- 3)

ACCESS CODE: 1) UPDATE CODES

 Select **[5] Prox Tag**.

- 4)

PROX TAG: 1) (RE)WRITE TAG

 Select **[3] Del By Tag**.









- 5)

APPROACH TAG TO PROX KEYPAD

 Within 10 seconds, approach the proximity tag at a distance of 3 to 7 cm. from the keypad's keys. If the proximity tag was deleted, the following confirmation message is displayed: **USER TAG XX DELETED**.
If the system does not recognize the proximity tag, the following message is displayed: **TAG NOT DEFINED IN MEMORY**.

Using a Proximity Tag

When using a proximity tag, the following points regarding assigned partitions are relevant:

- ◆ If your user code is assigned to **only one** partition, then the partition will arm or disarm automatically.
- ◆ If your user code is assigned to **more than one** partition, use the ,  or ,  keys to select the required partition(s) and press  ,  .



NOTE:

CE!: The proximity keypad is restricted from use in Greece.







➤ To use a proximity tag:



- ◆ Hold the proximity tag close to the keypad's keys at a distance of approximately 3 to 7 cm. Based on your user definitions:
 - ❖ The partition(s) assigned to your user code are armed/disarmed. (Ask your installer for the number of partitions that are assigned to your user code.)
 - OR-**
 - ❖ The defined home appliance(s) operates (based on its current status).

Chapter 13: Complete Menu of User Functions

Your ProSYS comes with a variety of selectable user functions that become available when you enter the *User Functions* mode. This chapter lists the complete menu of user functions, the most frequently used of which are described in detail in previous chapters of this manual.

To enter the *User Functions* mode, press  followed by the *Function Index* or quick key (see the table below) and your user code. For example, to activate Switch Auxiliary, press

   [1-2-3-4] ,  / .

To exit the *User Functions* mode and return to *Normal Operation* mode, press   quickly.

Quick Key	Function	Description
1 Bypass		
1	Bypass Zones	Provides the ability to bypass any of the system's intrusion zones, as described on page 30.
2	Bypass Reset	Removes any bypass(es) previously placed on an intrusion zone(s).
3	Bypass Recall	Recalls the most recent zone bypass(es).
4	Permanent Bypass	Provides the Grand Master the ability to bypass (and reset bypassing) any of the system's intrusion zones permanently. This feature is different from regular Zone Bypassing (Quick key [*][1][1]). While in regular bypassing, the zone returns to be Not Bypassed after it is armed, in Permanent Bypass the zone remains bypassed until the Grand Master changes its status.
5	Bypass Tamper	Provides the Grand Master or the Installer the ability to bypass bell or box tamper conditions. If Bypass Tamper is selected and a tamper condition occurs, the tamper LED on the LCD will light, there will be no alarm, no indication to the Monitoring Station and no record in the event log. Note that this feature should be enabled by your installer.

Quick Key	Function	Description
2 Activities		
1	Utility Output	Allows user control of previously designated external devices (e.g. an appliance, a motor-driven garage door, etc.), as described on page 32.
2	Switch Auxiliary	Interrupts the power supplied to the system's smoke detector(s) for a predetermined interval, thus resetting and "rearming" them for subsequent alarms, as described on page 29.
3	Terminate FM	If Follow Me Destination(s) were chosen, their operation can be terminated. Use this function when an alarm has been tripped and there is no need to utilize the Follow Me feature.
4	Initiate Call	By initiating a call to your Monitoring Station, this allows them to perform a remote programming operation on your system.
5	Hand Over	Similar in intent to Initiate Call (above), Hand Over allows your Monitoring Station to call you and, during the call, "hand over" to them the control of your security system.
6	Void Rep Prg	For installer use only. Some protocols have a report code to the monitoring station for entering and exiting the installer programming. To avoid the entering report and save time, this function postpones the report for two minutes during which the installer can enter the programming menu and no report will be made.
7	Follow Me	Allows the entry and/or editing of follow me destinations used with the Follow-Me feature. In case of an alarm, your system will generate a telephone call to a designated system phone or pager, send a sms/email, and, when connected to the Voice module, employ voice messages to announce the event that has occurred. Refer to page 34 for details about editing Follow Me destinations.
8	Enable U/D	Each time this function is enabled, your Monitoring Station may subsequently gain a single remote access to your system to make any required programming changes. Contact your dealer for additional information.
9	Del Rmt Msg	Deletes a message that has been sent to the LCD from the Upload/Download software.

Quick Key	Function	Description
0	More...	
01	Cancel Report	Sends a "Cancel Alarm" report message to the Monitoring Station. This function is used if the alarm was activated by mistake.
02	Overload Restore	The Grand Master/Installer /Sub-installer/Manager can use this option to restore overloading of the system's Switched Power Supply. If overload condition is still present, disconnect all loads from AUX. Output.
03	Check Credit	Use this function to receive information by SMS of the credit level in your Prepaid SIM card. The ProSYS will send SMS Credit Level Request message (User menu: Quick Key [4][0][4][1]) to the provider's phone (User menu: Quick Key [4][0][4][2]). Once the SMS is received by the provider, the SIM's credit level is sent back and displayed on the keypad's LCD display or sent to the Follow Me (if defined).
04	Reset SIM	After charging a prepaid SIM card, the user has to reset the SIM Expire Time manually. The time duration for expiration is defined by your installer.
05	User Call	Use this function to receive the SIM credit level using the voice channel. Upon accessing this option, a dial tone is received and the ProSYS keypad functions as a GSM telephone. You can dial and listen to messages as with a regular telephone. To end the call press the Stay key. Note the following : 1. The outgoing call will always be executed through the GSM channel. 2. Talking is not optional during the call. 3. This option can be used to get any provider information. The call can be established to any phone number.

3 View

1	Trouble	Should be used when the system has detected a problem, which is evidenced by the rapid flashing of the Power LED, as described on page 66.
2	Alarm Memory	Allows the viewing of the five most recent alarm conditions stored by the system.
3	Not Ready Status	Allows the viewing of all "not ready" zones.

Quick Key	Function	Description
4	Zone Status	Allows the display of all system zones and their current status.
5	Event Log	Allows the viewing of significant system events including date and time.
6	Service Info	Allows the display of any previously entered service information and the system version.
7	Overview	Select between the following LCD keypad display types: Single: The keypad displays the partition name, time, and date. All: the keypad displays the status of all relevant partitions. Each partition is represented by a status letter, as follows: <ul style="list-style-type: none"> ❖ A: Partition Armed ❖ S: Partition Stay Armed ❖ L: Partition in Alarm ❖ N: Partition Not Ready ❖ R: Partition Ready

4 Maintenance

1	Keypad Test	Momentarily tests the keypad indicators and the system's external sounder(s).
2	Battery Test	Tests the system's standby battery(ies).
3	Local Chime Off	Use to turn OFF a particular keypad's internal sounder for any function involving the Chime feature.
4	Local Chime On	Use to turn ON a particular keypad's internal sounder for any function involving the Chime feature.
5	Part. Chime Off	Use to disable the internal sounder for all keypads in the partition for any function involving the Chime feature.
6	Part. Chime On	Use to enable the internal sounder for all keypads in the partition for any function involving the Chime feature.
7	Local Buzzer Off	Use to turn OFF a particular keypad's internal sounder during both Entry and Exit Delay time periods and all fire and burglar alarms.
8	Local Buzzer On	Use to turn ON a particular keypad's internal sounder during both Entry and Exit Delay time periods and all fire and burglar alarms.

Quick Key	Function	Description
9	Diagnostics	Enables the Installer/Sub-installer to perform diagnostics tests for: BUS zones, power supply, siren and GSM/GPRS module.
0	More...	
1	Walk Test	Used to easily test and evaluate the operation of selected zones in your system.
2	Accessory Versions	Enables viewing the software version of the BUS zones, switched power supply, siren and GSM/GPRS module.
3	Get ACM IP	View the ACM IP address. Required for establishing remote communication for U/D through the IP network.
4	Prepaid SIM	When using Pre-paid SIM cards, these options are used to receive information regarding the SIM card credit level. For detailed information, refer to the manuals supplied with the GSM/GPRS module.

5 Access Code

1	Update Codes	Sets, changes, and deletes user codes, as described on page 36.
2	Authority	Links user codes with Authority Levels, as described on page 38.
3	Partition	Assigns partitions to users.
4	User label	Assigns labels to users (10 characters long).
5	Prox Tag	Assigns user codes to proximity tags, which are used with proximity keypads to arm and disarm the system, as described in the <i>LCD Proximity Keypad</i> instructions.
6	Digital Key	Programs digital keys, which are used to arm and disarm the system, if your system is equipped with this option.
7	Double Code	Assigns high-security double codes, as described on page 41.

6 Clocks

1	System Time	Allows the setting of the system time, as described on page 43.
2	System Date	Allows the setting of the system date, as described on page 44.

Quick Key	Function	Description
3	Next Arm	Used to automatically Away arm a disarmed system at a specific time within the next 24 hours. Next Arm works for one time only since the system deletes the setting after it is acted upon.
4	Next Disarm	Used to automatically disarm an armed system at a specific time within the next 24 hours. Next Disarm works for one time only since the system deletes the setting after it is acted upon.
5	Scheduler	Enables you to define a weekly schedule with up to two time intervals per day, during which the system automatically arms, activates UOs, or prevents users from disarming, as described on page 45.
6	Vacation	Use to define up to 20 vacation periods and the partitions that will be armed automatically during vacation.
7	User Limit.	This feature is used to enable or disable a user from any of the user limitation scheduling programs (Quick key [6][code][5][xx][3]). Note that deleting the schedule is not sufficient in order to disable a user from the user limitation schedule. You should also delete the user in this programming location.

7 Installer Prog

1	Advanced	Accesses the full menu of programming options.
2	Selected	Accesses a limited menu of programming options.

NOTE:

Refer to the *ProSYS Installation and Programming Manual* for more information about the **Installer Prog** functions.

8 Access Control

1	Settings	Defines the door mode for each door and the reader criteria for each reader in the system.
2	Time Schedule	Configures the time schedules by which users can access the system.
3	Group Access	Defines access to doors for groups of users during specific time periods.
4	Record Users	Adds Arm/Disarm users and Enter/Exit users to the system.

Quick Key	Function	Description
5	User Settings	Defines settings for users, including assigning PIN (Personal Identification Number) codes, assigning users to specific access groups, and deleting users.
6	Open Door	Remotely opens any door from any keypad that has previously been defined in the system.

NOTE:

Refer to the *Access Control User's Manual* for more information about the Access Control functions.

9 Miscellaneous

1	Printer Control (to control on-line printing)	1 Printer 1 on	Activates printer 1
		2 Printer 1 off	Deactivates messages to printer 1
		3 Printer 2 on	Activates printer 2
		4 Printer 2 off	Deactivates messages to printer 2
2	Anti-code	Some systems (defined during installation of the systems) are not ready to Arm after an alarm or tamper condition. To restore the system to <i>Normal Operation</i> mode, a technician code or an Anti-code must be entered. Entering the code supplied by the technician at this location will restore the system to the <i>Normal Operation</i> mode.	
3	Duress Restore	Deactivates a latched UO that has been activated as a result of a duress code being entered.	
4	Voice Msg	Customizes the spoken messages that are announced when the user accesses the system from a remote telephone. Refer to the <i>Voice Module Programming and Operations Manual</i> for more information.	
5	Key Custom	Records a series of commands and assigns them to a function key. For detailed information refer to page 52.	

Appendix A: System Troubles

The following table lists possible trouble conditions, their descriptions, and recommended responses.

Trouble	Description	LED KP	Response
Low Battery	The capacity of the battery is low or missing and needs to be recharged or replaced.	Zone 1 LED flashes.	Contact your dealer.
Loss of AC Power	The commercial power has been interrupted; the system will continue to operate on its standby battery as long as possible.	Zone 2 LED flashes.	Check the connection of the panel's transformer to its AC source. Be sure that power has not been interrupted or switched off.
Auxiliary Failure	The panel's auxiliary power, used to supply electric current to designated devices (e.g. motion detectors, keypads, and smoke detectors), has failed.	Zone 4 LED flashes.	Contact your dealer.
False Code Trouble	If enabled by your dealer, your system will report a false code as a trouble.	Zone 5 LED flashes.	Once the trouble has been displayed (LCD keypad only), it will automatically be removed from the system.
Phone Line Failure	The telephone line used for Monitoring Station communication is either disconnect-ed or inoperative.	Zone 6 LED flashes.	If all premises telephones are operating properly, contact your security dealer.
BUS Failure	A fault has been detected in the wiring supporting system peripherals. The trouble indicates the device with the communication trouble	Zone 7 LED flashes.	Contact your dealer.
Clock Not Set	The system's clock has lost track of the time and/or date.	Zone 8 LED flashes.	Set the system's time and date.

Trouble	Description	LED KP	Response
Low Battery in Power Supply Module	The capacity of the battery is low or missing and needs to be recharged or replaced	Zone 9 LED flashes. (Requires the 16-Zone LED keypad.)	Contact your dealer.
AC Loss in Power Supply Module	The commercial power has been interrupted to the Power Supply modle(s).	Zone 10 LED flashes. (Requires the 16-Zone LED keypad.)	Make sure the connection of this module's transformer to AC power has not been disturbed. Make sure that the outlet into which the module's transformer is plugged is ON.
Bell Troubled	Trouble has been detected in a bell conncted to the main panel or to the power supply expander	Zone 11 LED flashes (Requires the 16-Zone LED keypad.)	Contact your dealer.
Auxiliary Power Failure	auxiliary power from the optional Power Supply module(s).	Zone 12 LED flashes. (Requires the 16-Zone LED keypad.)	Contact your dealer.
Day Zone Trouble	A zone designated as a DAY ZONE has been faulted during the disarm period.	The designated zone flashes. (Requires the 16-Zone LED keypad.)	Check the integrity of the indicated zone.

Appendix B: System Sounds

In addition to the visual indications provided by your keypad(s), your system is designed to produce audible annunciation after certain events. Depending on the circumstance, such sounds may be made by your system's keypad(s) or sounders (e.g. a siren or bell).



NOTES:
If defined by your engineer, the internal bell can follow any of the keypad sounds

Event	Keypad Sound	Internal Bell	External Siren
Intrusion Alarm	Rapid beeping	Rapid beeping	Rapid beeping
Fire Alarm	Rapid beeping	Rapid beeping	YES (staggered)
Keypad Police Emergency	No Sound (1)	No Sound (1)	No Sound (1)
Keypad Emergency / Medsical	A momentary chirp	No sound	No sound
Arming or Disarming	No Sound	System is armed: 1 chirp System Disarmed: 2 chirp (Key-fob) Disarm after alarm: 4 chirps (Keyfob)	System is armed: 1 chirp
Correct / Incorrect Data	A one-second tone if completed correctly; three rapid error beeps if incorrect	No sound	No sound
Entry Delay Countdown	Slowly repeating tones until the Entry Delay time period expires (2)	No sound	No sound
Exit Delay Countdown	Slowly repeating tones until the Exit Delay time period expires (2)	No sound	No sound
Bell Circuit Failure or Fire Loop Trouble	Three rapid beeps at 10-second intervals (2,3)	No sound	No sound
Chime Sound	2 second buzzer beep (4)	No sound	No sound



NOTES:

1. Based on decisions made at the time your alarm system was installed, keypads may beep during this type of alarm.
2. Keypad beeps may be disabled at the user's discretion, see Buzzer On/Off under User Menu > Activities
3. Press **#/6** for two seconds to stop the fault beeps
- 4 Any intrusion zone, if selected for the Chime feature, will, when violated during the disarm period, cause the keypad to announce the event. The chime can also be disabled when not required

Appendix C: Scheduling Tables

Use the following table to define each of the weekly schedules.

Weekly Schedule : _____ Schedule Name: _____

Schedule Type		Parameter Definitions							
Arm / Disarm <input type="checkbox"/>	Partition	1	2	3	4	5	6	7	8
		<input type="checkbox"/>	<input type="checkbox"/>	<input type="checkbox"/>	<input type="checkbox"/>	<input type="checkbox"/>	<input type="checkbox"/>	<input type="checkbox"/>	<input type="checkbox"/>
	Arm Mode: <input type="checkbox"/> Arm <input type="checkbox"/> Home <input type="checkbox"/> Group	Select Group: <input type="checkbox"/> A <input type="checkbox"/> B <input type="checkbox"/> C <input type="checkbox"/> D							
Utility Output <input type="checkbox"/>	1st UO No: _____				3rd UO No: _____				
	2nd UO No: _____				4th UO No: _____				
NOTE: For the UO weekly schedule, you can define a separate time definition during vacation.									
User Access Authorization <input type="checkbox"/>	User #	Name		User #	Name				
NOTE: You can choose any user in the system.									
Day	Start Time 1 HH:MM	Stop Time 1 HH:MM	Start Time 2 HH:MM	Stop Time 2 HH:MM					
Sunday									
Monday									
Tuesday									
Wednesday									
Thursday									
Friday									
Saturday									

FCC Compliance Section

FCC Part 15 Note

This equipment has been tested and found to comply with the limits for a Class B digital device, pursuant to Part 15 of the FCC rules. These limits are designed to provide reasonable protection against harmful interference in a residential installation. This equipment generates, uses and can radiate radio frequency energy and, if not installed and used in accordance with the instructions, may cause harmful interference to radio communications. However, there is no guarantee that interference will not occur in a particular installation. If this equipment does cause harmful interference to radio or television reception, which can be determined by turning the equipment off and on, the user is encouraged to try to correct the interference by one or more of the following measures:

- ◆ Reorient or relocate the receiving antenna.
- ◆ Increase the separation between the equipment and receiver.
- ◆ Connect the equipment to an outlet on a circuit different from that to which the receiver is connected.
- ◆ Consult the dealer or an experienced radio/TV technician.

FCC Warning

The manufacturer is not responsible for any radio or TV interference caused by unauthorized modifications to this equipment. Such modifications could void the user's authority to operate the equipment.

FCC Part 68 Note (Telecom)

- 1) This equipment complies with Part 68 of the FCC Rules and the requirements adopted by the ACTA. On the bottom panel of this equipment is a label, that contains among other information, a product identifier in the format US:RISAL10BMD2400. If requested, this number must be provided to the telephone company.
- 2) This equipment is designed to be connected to the telephone network using a terminal block, RJ31X or RJ 11. See Installation Instructions for details.
- 3) A plug and jack used to connect this equipment to the premises wiring and telephone network must comply with the applicable FCC Part 68

rules and requirements adopted by the ACTA. A compliant telephone cord and modular plug is provided with this product. It is designed to be connected to a compatible modular jack that is also compliant. See installation instructions for details.

- 4) The REN is used to determine the number of devices that may be connected to a telephone line. Excessive RENs on a telephone line may result in the devices not ringing in response to an incoming call. In most but not all areas, the sum of RENs should not exceed five (5.0). To be certain of the number of devices that may be connected to a line, as determined by the total RENs, contact the local telephone company. The REN of this alarm system is part of the product identifier that has the format US:RISAL10BMD2400.
- 5) If this equipment US:RISAL10BMD2400 causes harm to the telephone network, the telephone company will notify you in advance that temporary discontinuance of service may be required. But if advance notice is not practical, the telephone company will notify the customer as soon as possible. Also, you will be advised of your right to file a complaint with the FCC if you believe it is necessary.
- 6) The telephone company may make changes in its facilities, equipment, operations or procedures that could affect the operation of the equipment. If this happens the telephone company will provide advance notice in order for you to make necessary modifications to maintain uninterrupted service.
- 7) If trouble is experienced with this equipment US:RISAL10BMD2400, for repair or warranty information please contact RISCO Group USA Inc 2822 NW 79th Ave. Miami, Florida 33122 USA, phone number 305 592 3820, URL: sales@riscogroup.com.
If the equipment is causing harm to the telephone network, the telephone company may request that you disconnect the equipment until the problem is resolved.
- 8) The user or installer is not to make any repairs to the product or the telephone interface, in case of problems please contact RISCO's customer service.
- 9) Connection to party line service is subjected to state tariffs. Contact the state public utility commission, public service commission or corporation for information.
- 10) If your home has additional alarm dialing equipment other than the ProSYS system which is connected to the telephone line, ensure the installation of this equipment US:RISAL10BMD2400 does not disable your alarm equipment. If you have questions about what will disable alarm equipment, consult your telephone company or qualified installer.

Caution:



To ensure proper operation, this equipment must be installed according to the enclosed installation instructions. To verify that the equipment is operating properly and can successfully report an alarm, this equipment must be tested immediately after installation, and periodically thereafter, according to the enclosed test.

Equipment must be installed according to the manufacturer instructions in order for the alarm dialing equipment to work properly when other equipment connected to the same line is in use, see drawing below for info.

Verification of the Line Seize capability should be made immediately after installation, and periodically thereafter, in order to ensure that this equipment can initiate a call even when other equipment (telephone, answering machine, computer modem, etc.) connected to the same line in use.

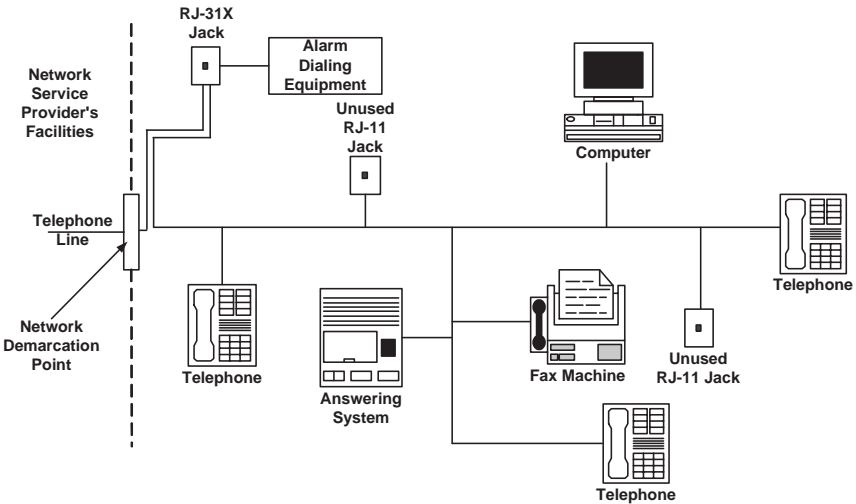

Customer Premises Equipment and Wiring

FCC Part 68 Self Declaraion (Telecom):



Date: December 18, 2008
Ref: sDOC_2400BPS_modem_ACTA

Supplier Declaration of Conformity (SdoC)

December 4, 2008

Risco Ltd., Located at 14 Hachoma street, Rishon Lezion 75655, Israel,
Hereby declare that the 2400 BPS modem,
p/n RF128MD2400A, RW132MD2400A, bearing labeling identification number
US.RISAL10BMD2400 complies with the Federal Communications commission's
("FCC") rules and regulations 47 CFR part 68, and the Administrative Council on
Terminal Attachments ("ACTA") adopted technical criteria: TIA-968-A, TIA-968-A-
1, TIA-968-A-2 and TIA-968-A-3, TIA-968-A-4, TIA-968-A-5, TIA-1096 and
TIA-1096-A, Telecommunications – Telephone Terminal Equipment – Technical
Requirements for Connection of Terminal Equipment To the Telephone Network.

Signed,

Efi Goren
Certification Manager
Risco Ltd.

A handwritten signature in black ink, appearing to read "Efi Goren", is written over a light blue rectangular background.

www.riscogroup.com

RISCO Group Limited Warranty

RISCO Group and its subsidiaries and affiliates ("Seller") warrants its products to be free from defects in materials and workmanship under normal use for 24 months from the date of production. Because Seller does not install or connect the product and because the product may be used in conjunction with products not manufactured by the Seller, Seller can not guarantee the performance of the security system which uses this product. Sellers obligation and liability under this warranty is expressly limited to repairing and replacing, at Sellers option, within a reasonable time after the date of delivery, any product not meeting the specifications. Seller makes no other warranty, expressed or implied, and makes no warranty of merchantability or of fitness for any particular purpose. In no case shall seller be liable for any consequential or incidental damages for breach of this or any other warranty, expressed or implied, or upon any other basis of liability whatsoever.

Sellers obligation under this warranty shall not include any transportation charges or costs of installation or any liability for direct, indirect, or consequential damages or delay.

Seller does not represent that its product may not be compromised or circumvented; that the product will prevent any person; injury or property loss by burglary, robbery, fire or otherwise; or that the product will in all cases provide adequate warning or protection. Buyer understands that a properly installed and maintained alarm may only reduce the risk of burglary, robbery or fire without warning, but is not insurance or a guaranty that such will not occur or that there will be no personal injury or property loss as a result.

Consequently seller shall have no liability for any personal injury, property damage or loss based on a claim that the product fails to give warning. However, if seller is held liable, whether directly or indirectly, for any loss or damage arising from under this limited warranty or otherwise, regardless of cause or origin, sellers maximum liability shall not exceed the purchase price of the product, which shall be complete and exclusive remedy against seller. No employee or representative of Seller is authorized to change this warranty in any way or grant any other warranty.

WARNING: This product should be tested at least once a week.

Contacting RISCO Group

RISCO Group is committed to customer service and product support. You can contact us through our website (www.riscogroup.com) or as follows:

United Kingdom

Tel: +44-161-655-5500
technical@riscogroup.co.uk

USA

Tel: +1-631-719-4400
support-usa@riscogroup.com

Italy

Tel: +39-02-66590054
support@riscogroup.it

Brazil

Tel: +1-866-969-5111
support-br@riscogroup.com

Spain

Tel: +34-91-490-2133
support-es@riscogroup.com

China

Tel: +86-21-52-39-0066
support-cn@riscogroup.com

France

Tel: +33-164-73-28-50
support-fr@riscogroup.com

Poland

Tel: +48-22-500-28-40
support-pl@riscogroup.com

Belgium

Tel: +32-2522-7622
support-be@riscogroup.com

Israel

Tel: +972-3-963-7777
support@riscogroup.com



All rights reserved.

No part of this document may be reproduced in any form without prior written permission from the publisher.